



**Extrtreme Low VF Schottky Barrier Rectifiers**  
Reverse Voltage - 100 Volts  
Forward Current - 30 Amperes

**Features**

- Super Low Forward Voltage Drop
- Reliable High Temperature Operation
- Softest, fast switching capability
- 150 °C Operating Junction Temperature
- Lead Free Finish, RoHS Compliant

**Mechanical data**

- Case: TO-220-3L
- Approx Weight: 2.04g ( 0.07oz)
- Case Material: “Green” molding compound, UL flammability classification 94V-0, “Halogen-free”.

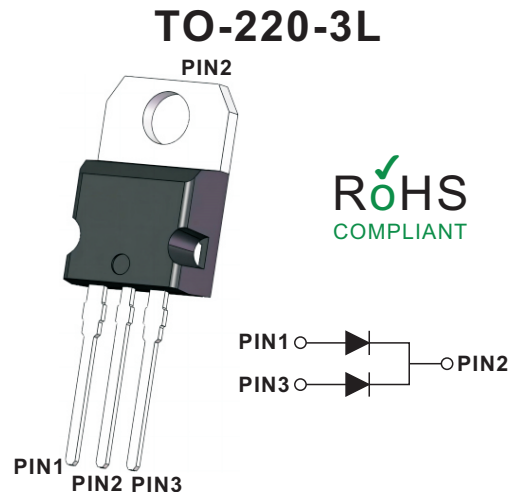

RoHS  
COMPLIANT

**Packing Marking And Ordering Information**

Device Package	Device	Marking	Packing Type	QTY Per Tube	Inner box	Per Carton
TO-220-3L	MBRT30100CD	MBRT30100CD	Tube	50 Pcs	2,500 Pcs	5,000 Pcs

**Maximum Ratings And Electrical Characteristics**

Ratings At 25°C Ambient Temperature Unless Otherwise Specified

Characteristics	Symbols	MBRT30100CD	Units
Maximum Recurrent Peak Reverse Voltage	$V_{RRM}$	100	V
Maximum RMS voltage	$V_{RMS}$	70	V
Maximum DC Blocking Voltage	$V_{DC}$	100	V
Average Rectified Forward Current Per leg Per device	$I_O$	15 30	A
Peak Forward Surge Current, 8.3ms Single Half Sine-wave Superimposed on Rated Load (JEDEC method)(Per leg)	$I_{FSM}$	200	A
Operating Junction Temperature Range	$T_j$	-55 ~ +150	°C
Storage Temperature Range	$T_{stg}$	-55 ~ +150	°C

Characteristics	Symbols	Test Conditions	Min	Typ	Max	Units
Breakdown voltage per leg	$V_{BR}$	$I_R=0.5mA$	100			V
Instantaneous forward voltage per leg	$V_F$	$I_F=15A, T_J=25^\circ C$		0.70	0.75	V
Reverse current per leg	$I_R$	$V_R=100, T_J=25^\circ C$			0.25	mA



Fig.1 Typical Forward Current Derating Curve

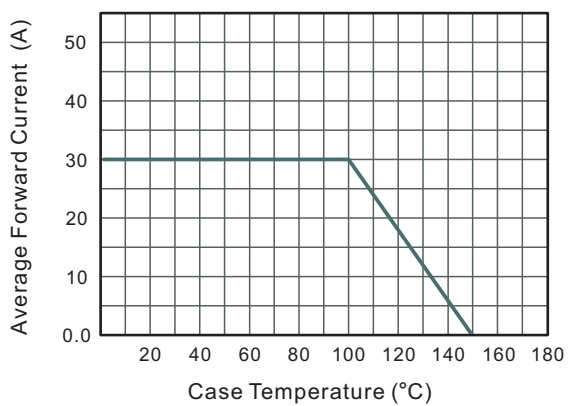

Fig.2 Typical Reverse Characteristics

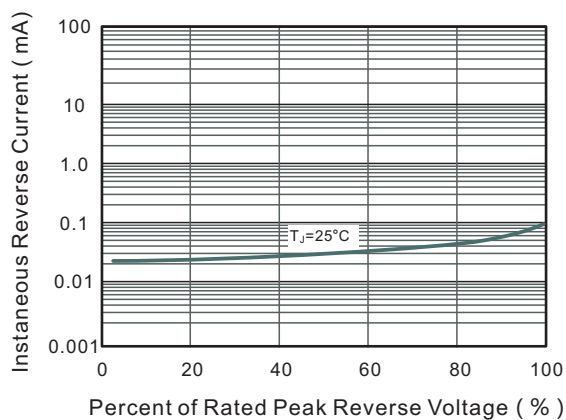

Fig.3 Typical Forward Characteristic(per leg)

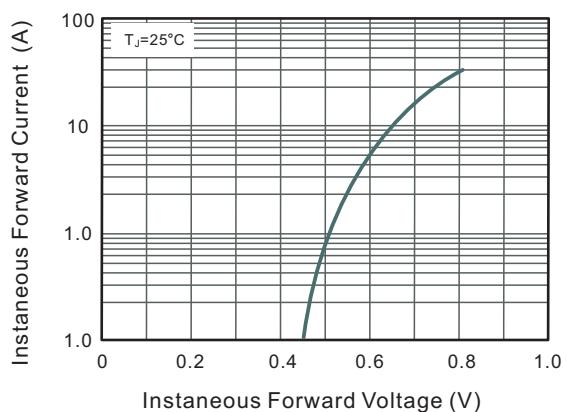
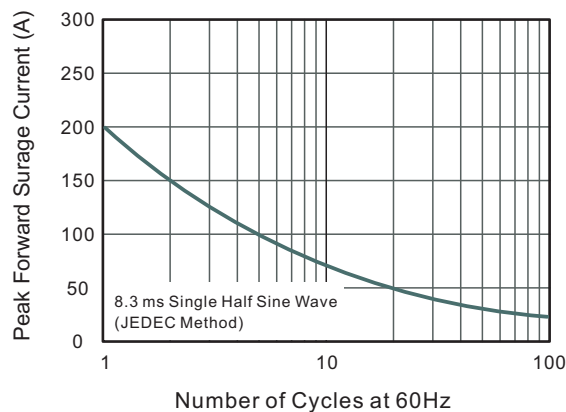

Fig.4 Maximum Non-Repetitive Peak Forward Surge Current





Package Outline  
Through Hole Package ; 3 leads

TO-220-3L

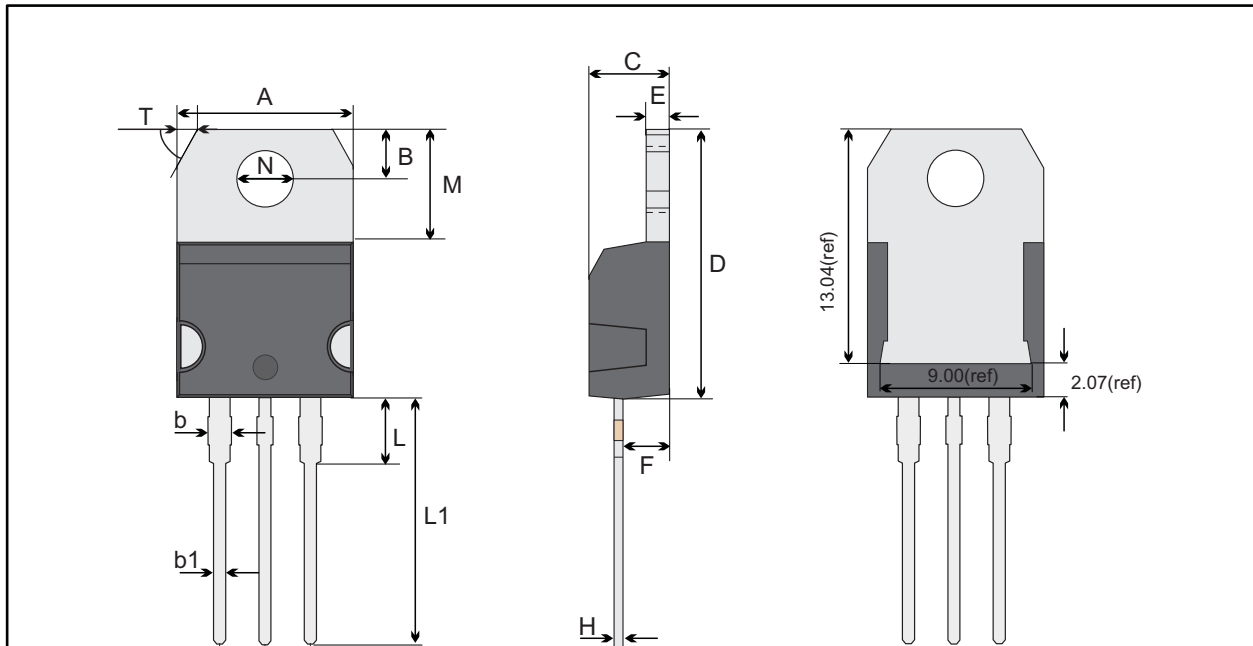

TO-220-3L mechanical data

UNIT		A	B	b	b1	C	D	E	F	G	H	L	L1	M	N	T
mm	max	10.28	2.84	1.67	0.9	4.65	15.54	1.37	2.79	2.64	0.6	3.88	13.13	6.39	3.82 typ.	1.19 58° ref.
	typ	10.18	2.74	1.47	0.8	4.45	15.34	1.27	2.59	2.54	0.5	3.68	12.93	6.19		
	min	10.08	2.64	1.27	0.7	4.25	15.14	1.17	2.39	2.44	0.4	3.48	12.73	5.99		
mil	max	405	112	66	35	183	612	54	110	104	24	153	517	252	150 typ.	47 58° ref.
	typ	401	108	58	31	175	604	50	102	100	20	145	509	244		
	min	397	104	50	28	167	596	46	94	92	16	137	501	236		

### Marking Diagram

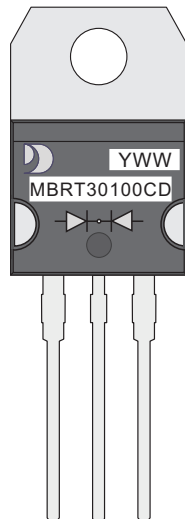

YWW: Date Code  
Y: Years(0~9)  
WW: Week  
MBRT30100CD: Product name  
(NOTE: The weekly code is based on the actual number of weeks in the calendar year.)



### **Important Notice and Disclaimer**

Jingdao Microelectronics reserves the right to make changes to this document and its products and specifications at any time without notice. Customers should obtain and confirm the latest product information and specifications before final design, purchase or use.

Jingdao Microelectronics makes no warranty, representation or guarantee regarding the suitability of its products for any particular purpose, not does Jingdao Microelectronics assume any liability for application assistance or customer product design.

Jingdao Microelectronics does not warrant or accept any liability with products which are purchased or used for any unintended or unauthorized application.

No license is granted by implication or otherwise under any intellectual property rights of Jingdao Microelectronics.

Jingdao Microelectronics products are not authorized for use as critical components in life support devices or systems without express written approval of Jingdao Microelectronics.