

Dual N-channel Enhancement Mode Power MOSFET

Features

- 20V, 5A
 - RDS(ON) <math>< 26\text{m}\Omega</math> @ VGS=4.5V
 - RDS(ON) <math>< 26\text{m}\Omega</math> @ VGS=2.5V
- Advanced Trench Technology
- Provide Excellent RDS(ON) and Low Gate Charge
- Lead free product is acquired

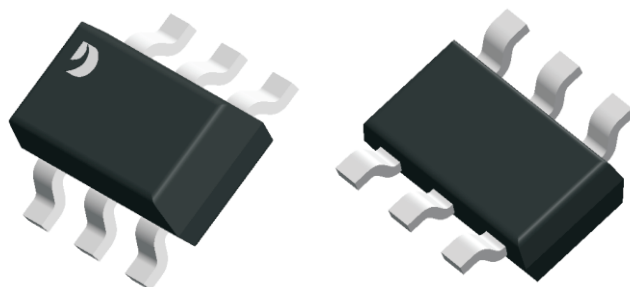

Application

- Load Switch
- PWM Application
- Power management

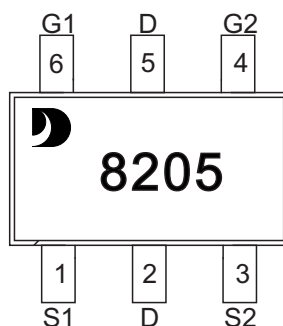

Marking and pin Assignment

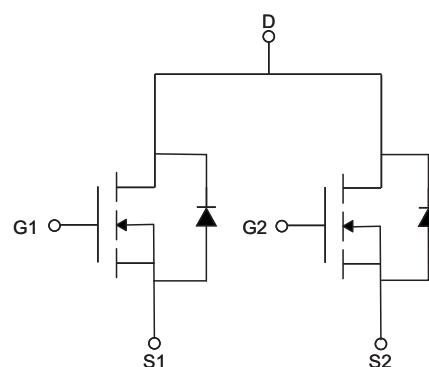

Schematic Diagram

Absolute Maximum Ratings (T_A=25°C unless otherwise specified)

Symbol	Parameter	Max	Units
V _{DSS}	Drain-Source Voltage	20	V
V _{GSS}	Gate-Source Voltage	±10	V
I _D	Continuous Drain Current	T _A =25°C	5
		T _A =100°C	3.2
I _{DM}	Pulsed Drain Current ^{Note1}	20	A
P _D	Power Dissipation	1.5	W
R _{θJA}	Thermal Resistance, Junction to Ambient	83.3	°C/W
T _J , T _{STG}	Operating and Storage Temperature Range	-50 to +150	°C

Note: 1. Repetitive Rating : Pulse Width Limited by Maximum Junction Temperature



Electrical Characteristics

Ratings at 25 °C ambient temperature unless otherwise specified.

Parameter	Symbol	Conditions	Minimum	Typical	Maximum	Units
Drain-Source Breakdown Voltage	B_{VDSS}	$V_{GS}=0V, I_D=250\mu A$	20	21		V
Static Drain-Source On-Resistance	$R_{DS(on)}(FT)$	$V_{GS}=4.5V, I_D=4.0A$		20	25	m Ω
		$V_{GS}=2.5V, I_D=3.0A$		26	36	m Ω
Gate Threshold Voltage	$V_{GS(th)}$	$V_{GS}=V_{DS}, I_D=250\mu A$	0.45	0.7	1.1	V
Gate-to-Source Leakage Current	I_{DSS}	$V_{DS}=20V, V_{GS}=0V$			1	μA
Gate-Body Leakage Current	I_{GSS}	$V_{DS}=0V, V_{GS}=\pm 10V$			± 100	nA
Input Capacitance	C_{iss}	$V_{DS}=10V, V_{GS}=0V$ $f=1.0MHz$		800		pF
Output Capacitance	C_{oss}			155		pF
Reverse Transfer Capacitance	C_{rss}			125		pF
Total Gate Charge	Q_g	$V_{DS}=10V, V_{GS}=4.5V$ $I_D=3A$		11		nC
Gate-Source Charge	Q_{gs}			2.3		nC
Gate-Drain("Miller") Charge	Q_{gd}			2.5		nC
Turn-on Delay Time	$t_{d(on)}$	$V_{DS}=10V, V_{GS}=4.5V$ $I_D=3A, R_{GEN}=3\Omega$		18		ns
Turn-on Rise Time	t_r			5		ns
Turn-off Delay Time	$t_{d(off)}$			43		ns
Turn-off Fall Time	t_f			20		ns



Typical Electrical and Thermal Characteristics

Fig.1 Capacitance vs.Drain-Source Voltage

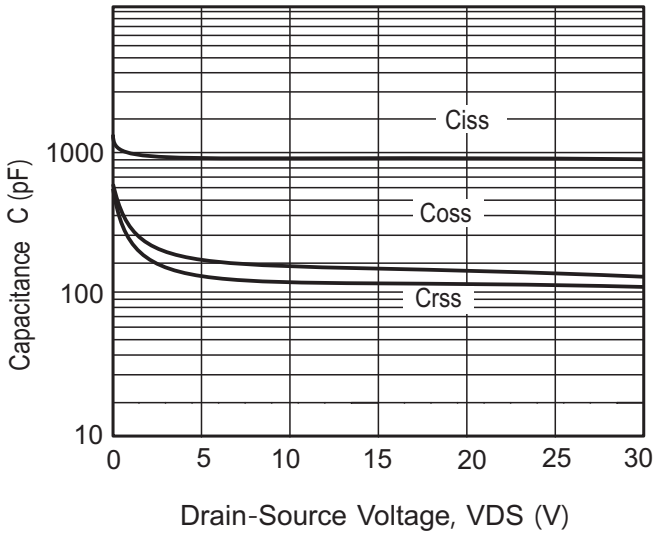

Fig.2 Gate Charge Vs.Gate-Source Voltage

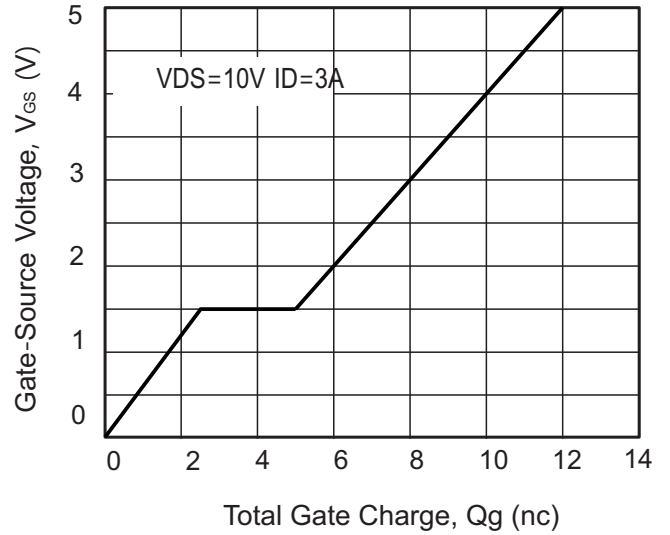

Fig 3 Output Characteristics

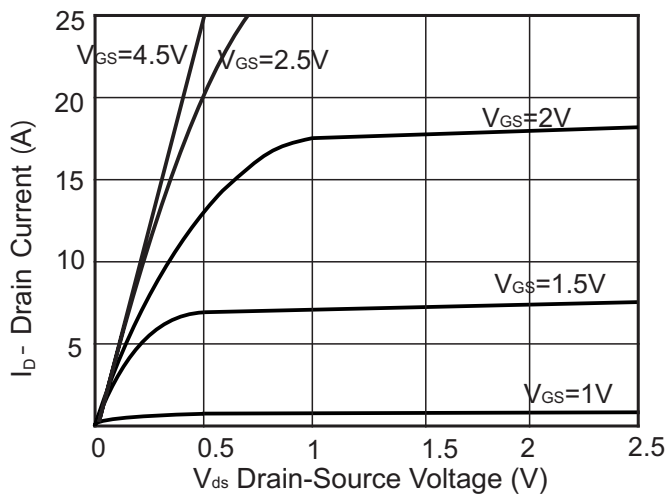

Fig 4 Drain-Source On-Resistance

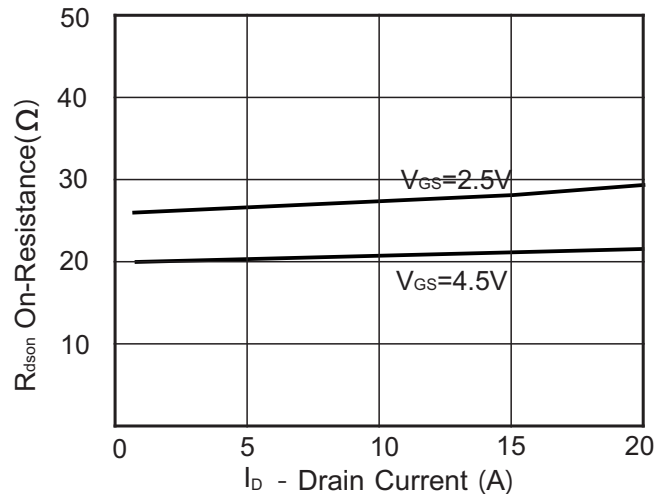

Fig 5 Transfer Characteristics

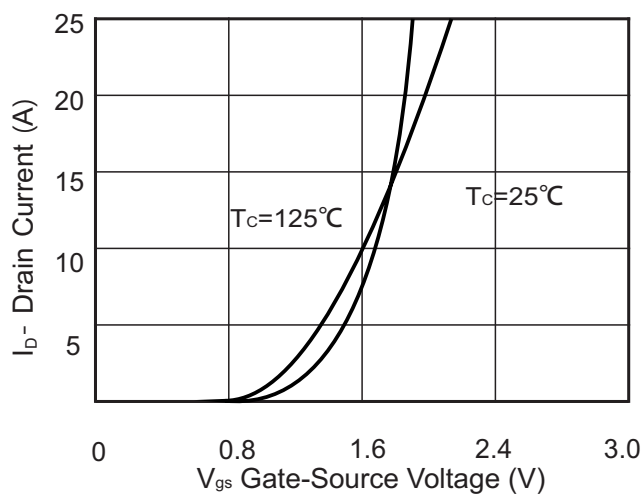

Fig 6 Source- Drain Diode Forward

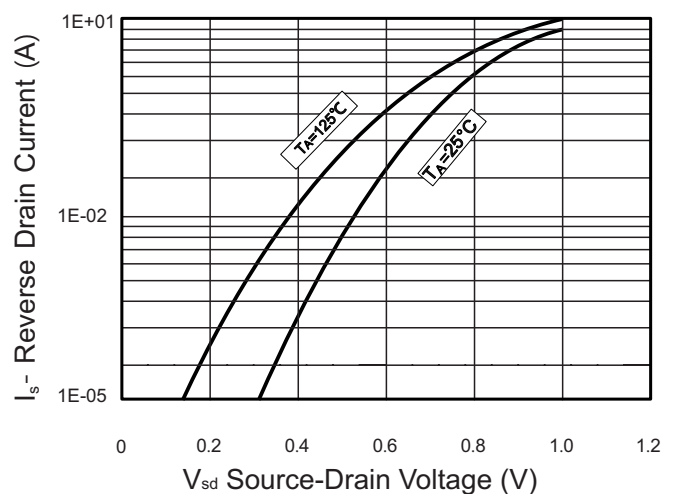



Fig 7 Safe Operation Area

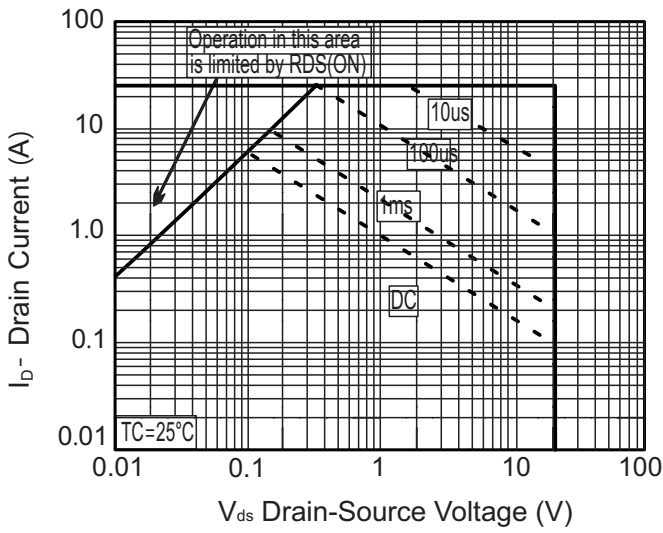

Fig 8 Normalized Breakdown Voltage vs . Junction Temperature

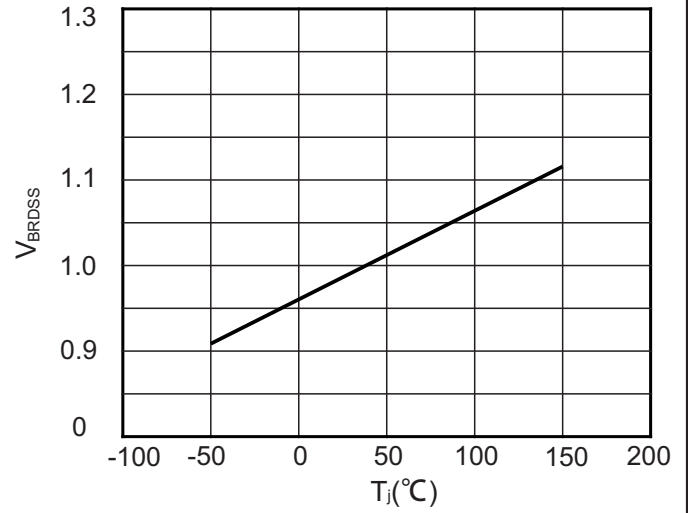

Fig 9 Normalized on Resistance vs . Junction Temperature

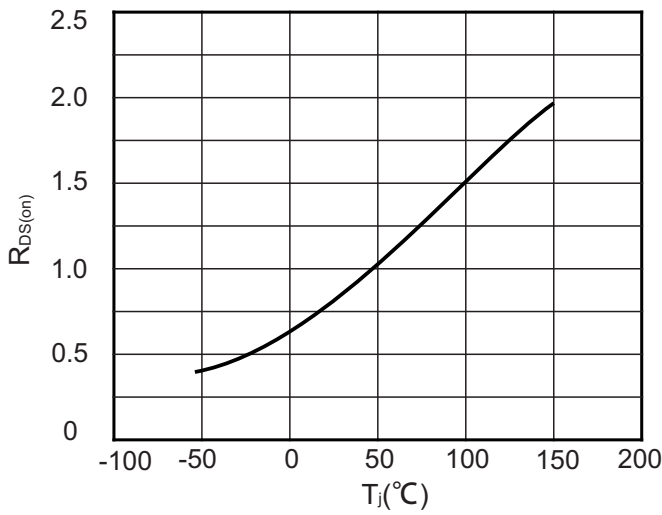
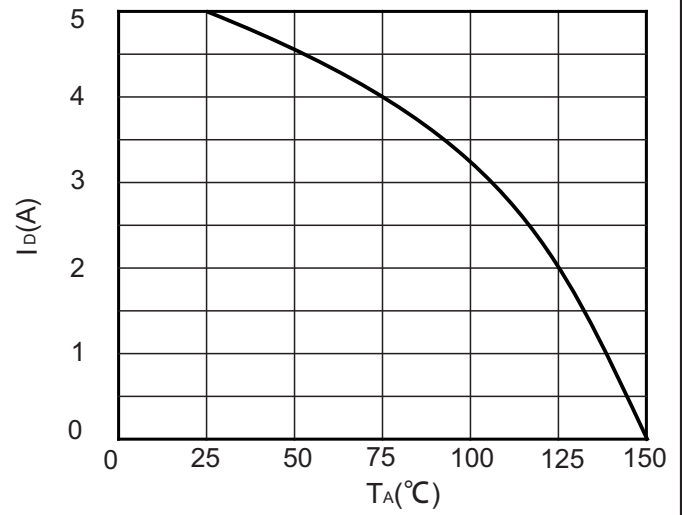

Fig 9 Maximum Continuous Drain Current vs . Ambient Temperature





PACKAGE OUTLINE

Plastic surface mounted package; 6 leads

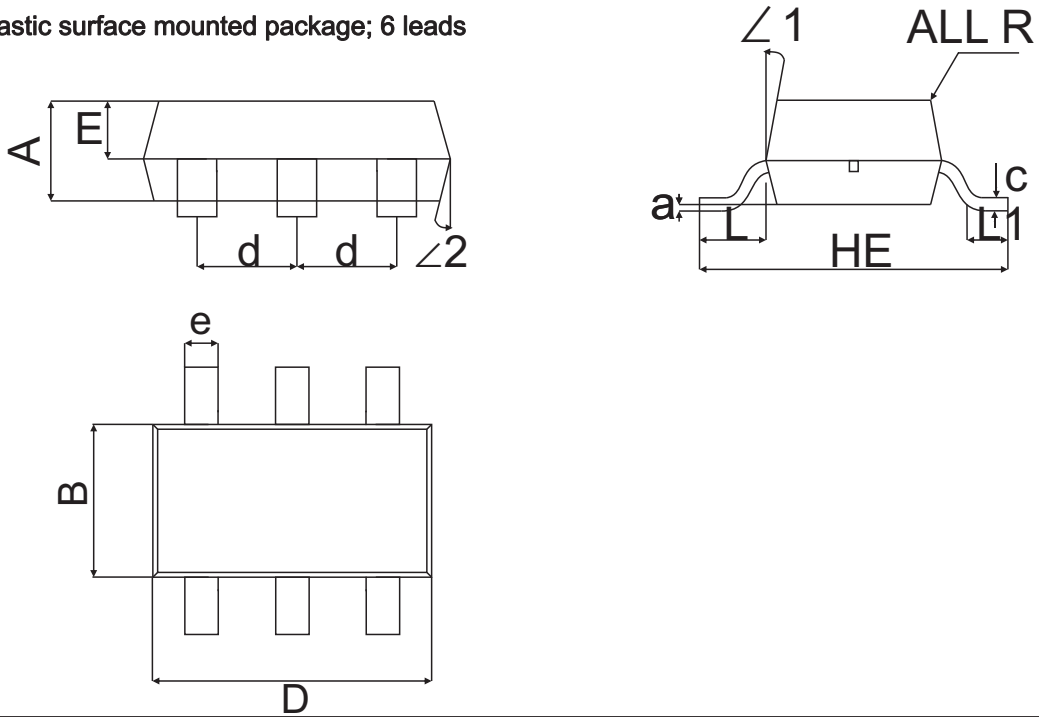

Unit		A	B	C	HE	D	d	E	e	L	L1	a	R	∠1	∠2
mm	max	1.05	1.80	0.20	2.90	3.12	1.00	0.65	0.40	0.70	0.60	0.2 (ref)	R0.1 (ref)	12°	10°
	typ	0.95	1.60	0.15	2.80	2.92	0.95	0.55	0.35	0.60	/				
	min	0.85	1.40	0.10	2.70	2.72	0.90	0.45	0.30	0.50	0.20				
mil	max	41	71	8	114	123	39	26	16	28	24	8 (ref)	R4 (ref)		
	typ	37	63	6	110	115	37	22	14	24	/				
	min	33	55	4	106	107	35	18	12	20	8				

The recommended mounting pad size

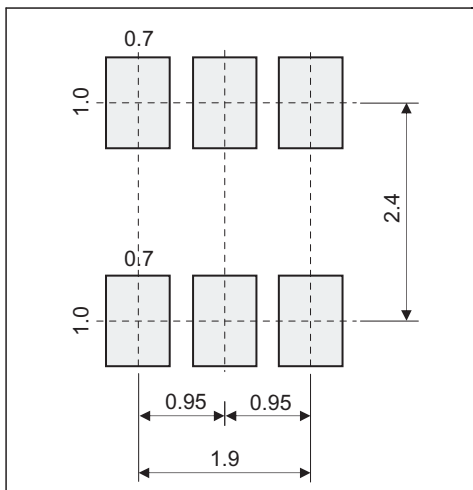

Marking

Type number	Marking code
NM8205	8205

