

**Fast Recovery Diodes**  
**Reverse Voltage – 1000 Volts**  
**Forward Current – 30 Amperes**

**Features**

- High frequency operation
- High surge forward current capability
- High purity, high temperature epoxy encapsulation for enhanced mechanical strength and moisture resistance
- Guard ring for enhanced ruggedness and long term reliability
- Solder dip 275 °C max. 7s, per JESD 22-B106

**Mechanical data**

- Case: TO-247-3L
- Approx. Weight: 6.3g ( 0.22oz)
- Lead free finish, RoHS compliant
- Case Material: “Green” molding compound, UL flammability classification 94V-0, “Halogen-free”.

TO-247-3L

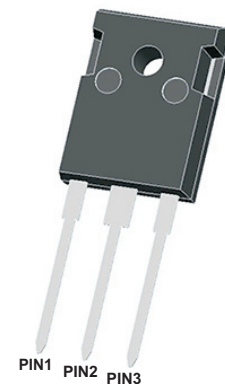

SYMBOL

  
 ROHS  
 COMPLIANT



MAXIMUM RATINGS AND ELECTRICAL CHARACTERISTICS

Ratings at 25°C ambient temperature unless otherwise specified

PARAMETER	Symbols	FR30100WD	Units
Maximum Recurrent Peak Reverse Voltage	$V_{RRM}$	1000	V
Maximum RMS voltage	$V_{RMS}$	700	V
Maximum DC blocking Voltage	$V_{DC}$	1000	V
Maximum Average Forward Rectified Current @Tc=100°C	$I_{F(AV)}$ per leg per device	15 30	A
Peak Forward Surge Current, 8.3ms Single Half Sine-wave Superimposed on Rated Load (JEDEC method)	$I_{FSM}$	250	A
Instantaneous forward voltage at 15A	$V_F$ per leg	1.60	V
Maximum instantaneous reverse current at rated DC blocking voltage	$I_R$ Ta=25°C Ta=125°C	10 500	uA
Maximum Reverse Recovery Time NOTE 1	trr	150	ns
Maximum Thermal Resistance Junction To Case	$R_{\theta JC}$	4	°C/W
Operation Junction Temperature and Storage Temperature	$T_j, T_{stg}$	-55 ~ +150	°C

NOTE 1: Reverse recovery test conditions  $I_F=0.5A, I_R=1.0A, I_{rr}=0.25A$



Fig.1 TYPICAL FORWARD CURRENT DERATING CURVE

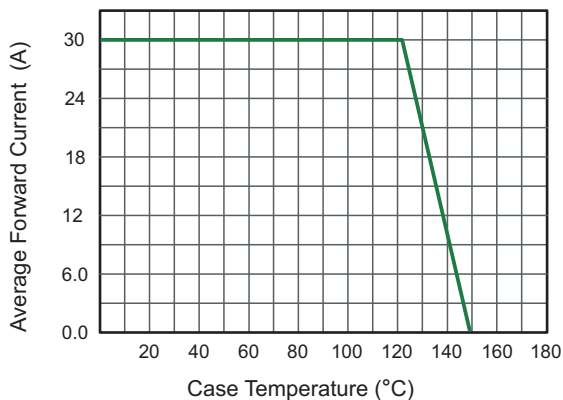

Fig.2 Typical Reverse Characteristics

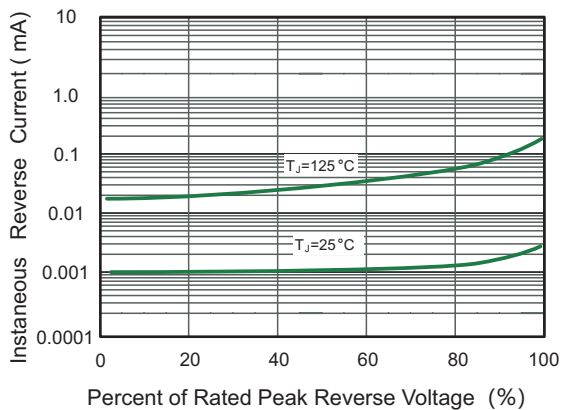

Fig.3 Typical Forward Characteristics

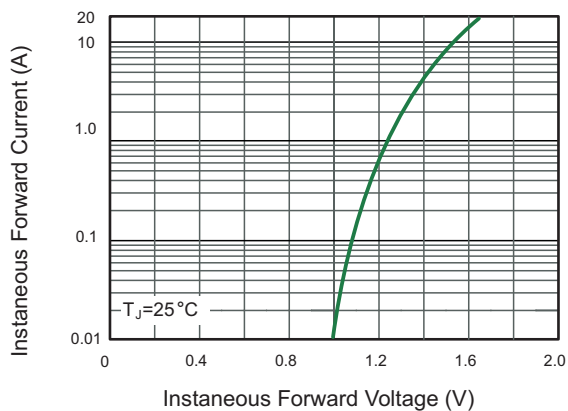
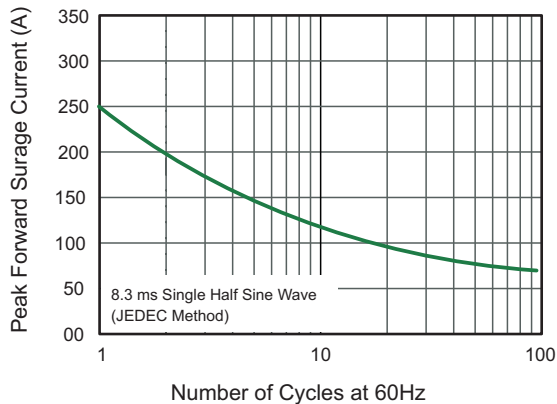

Fig.4 Maximum Non-Repetitive Peak Forward Surge Current





PACKAGE OUTLINE

Plastic surface mounted package; 3 leads

TO-247-3L

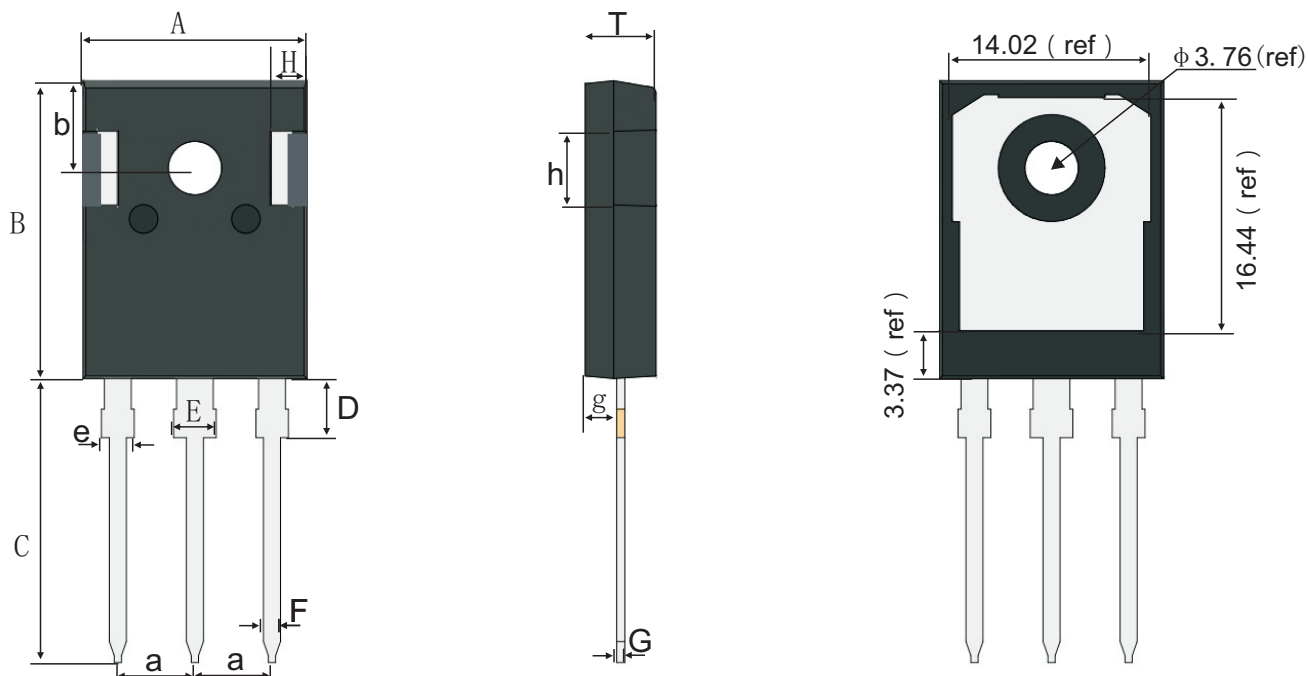

TO-247-3L mechanical data

UNIT		A	B	b	C	D	E	e	F	g	G	T	t	a	H	h
mm	max	16.01	21.18	6.26	20.2	4.25	3.15	2.20	1.30	2.49	0.70	5.20	2.21	5.54	2.71	5.37
	typ	15.81	20.98	6.16	20.0	4.15	3.00	2.05	1.20	2.39	0.60	5.00	2.01	5.44	2.51	5.17
	min	15.61	20.78	6.06	19.8	4.05	2.85	1.90	1.10	2.29	0.50	4.80	1.81	5.34	2.31	4.97
mil	max	630	834	246	795	167	124	87	51	98	28	205	87	218	107	211
	typ	622	826	243	787	163	118	81	47	94	24	197	79	214	99	204
	min	615	818	239	780	159	112	75	43	90	20	189	71	210	91	196

MARKING DIAGRAM

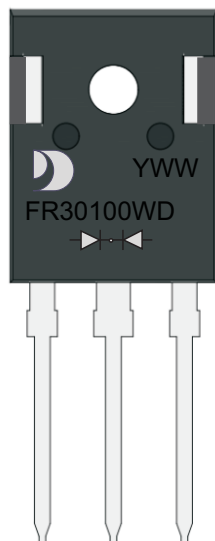

YWW: Date Code  
Y: Years(0~9)  
WW: Week  
FR30100WD: Product name  
(NOTE: The weekly code is based on the actual number of weeks in the calendar year.)



### Important Notice and Disclaimer

Jingdao Microelectronics reserves the right to make changes to this document and its products and specifications at any time without notice. Customers should obtain and confirm the latest product information and specifications before final design, purchase or use.

Jingdao Microelectronics makes no warranty, representation or guarantee regarding the suitability of its products for any particular purpose, nor does Jingdao Microelectronics assume any liability for application assistance or customer product design.

Jingdao Microelectronics does not warrant or accept any liability with products which are purchased or used for any unintended or unauthorized application.

No license is granted by implication or otherwise under any intellectual property rights of Jingdao Microelectronics.

Jingdao Microelectronics products are not authorized for use as critical components in life support devices or systems without express written approval of Jingdao Microelectronics.