



2A SURFACE MOUNT GLASS PASSIVATED BRIDGE RECTIFIER

FEATURES:

- Glass Passivated Chip Junction
- Reverse Voltage - 100 to 1000 V
- Forward Current - 2.0 A
- Fast reverse recovery time
- Designed for Surface Mount Application

PINNING

PIN	DESCRIPTION
1	Input Pin (~)
2	Input Pin (~)
3	Output Anode (+)
4	Output Cathode (-)

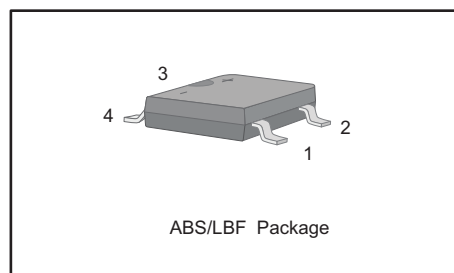

MECHANICAL DATA

- Case: ABS/LBF
- Terminals: Solderable per MIL-STD-750, Method 2026
- Approx. Weight: 88mg/0.0029oz

Maximum Ratings and Electrical characteristics

Ratings at 25 °C ambient temperature unless otherwise specified.

Single phase half-wave 60 Hz, resistive or inductive load, for capacitive load current derate by 20 %.

Parameter	Symbols	UTB1S-20	UTB2S-20	UTB4S-20	UTB6S-20	UTB8S-20	UTB10S-20	Units
Maximum Repetitive Peak Reverse Voltage	V_{RRM}	100	200	400	600	800	1000	V
Maximum RMS voltage	V_{RMS}	70	140	280	420	560	700	V
Maximum DC Blocking Voltage	V_{DC}	100	200	400	600	800	1000	V
Average Rectified Output Current at $T_c = 125\text{ }^\circ\text{C}$	I_O	2.0						A
Peak Forward Surge Current 8.3 ms Single Half Sine Wave Superimposed on Rated Load (JEDEC Method)	I_{FSM}	55						A
Maximum Forward Voltage at 2 A	V_F	1.0		1.4		1.65		V
Maximum DC Reverse Current at Rated DC Blocking Voltage $T_a = 25\text{ }^\circ\text{C}$ $T_a = 125\text{ }^\circ\text{C}$	I_R	5.0 100						μA
Typical Junction Capacitance ¹⁾	C_j	35						pF
Maximum Reverse Recovery Time ²⁾	t_{rr}	50			75			ns
Typical Thermal Resistance ³⁾	$R_{\theta JA}$ $R_{\theta JC}$	60 20						$^\circ\text{C/W}$
Operating and Storage Temperature Range	T_j, T_{stg}	-55 ~ +150						$^\circ\text{C}$

1) Measured at 1 MHz and applied reverse voltage of 4 V D.C

2) Measured with $I_F = 0.5\text{ A}$, $I_R = 1\text{ A}$, $I_{rr} = 0.25\text{ A}$

3) P.C.B. mounted with $4 \times 1.5'' \times 1.5''$ ($3.81 \times 3.81\text{ cm}$) copper pad areas.



Fig.1 Reverse Recovery Time Characteristic And Test Circuit Diagram

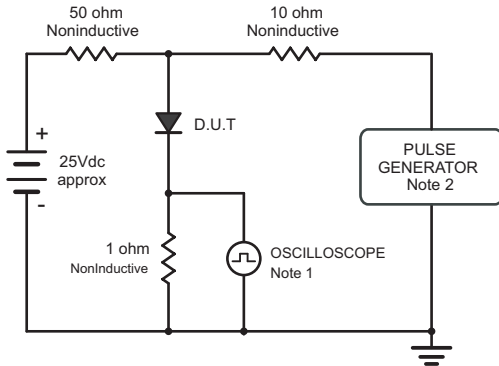

Note: 1. Rise Time = 7ns, max.
Input Impedance = 1megohm, 22pF.
2. Rise Time = 10ns, max.
Source Impedance = 50 ohms.

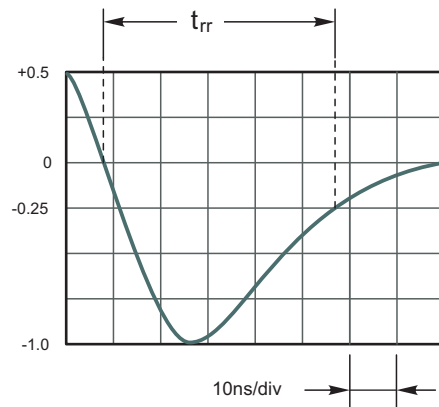

Set time Base for 10ns/div

Fig.2 Maximum Average Forward Current Rating

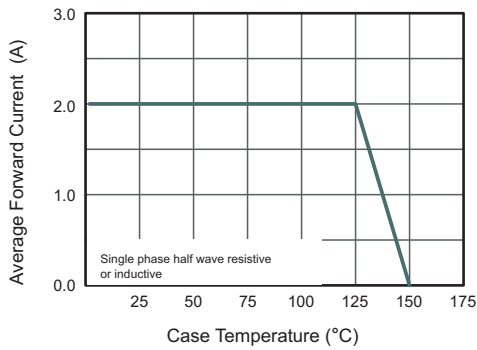

Fig.3 Typical Reverse Characteristics

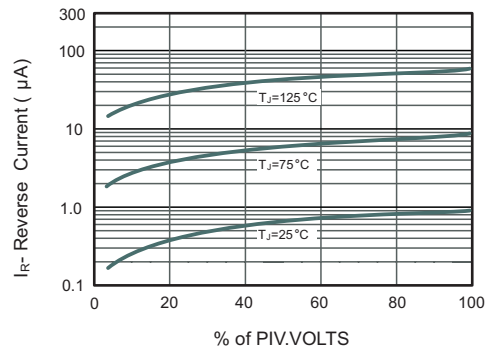

Fig.3 Typical Instantaneous Forward Characteristics

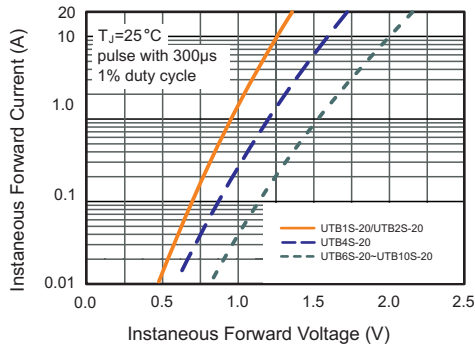
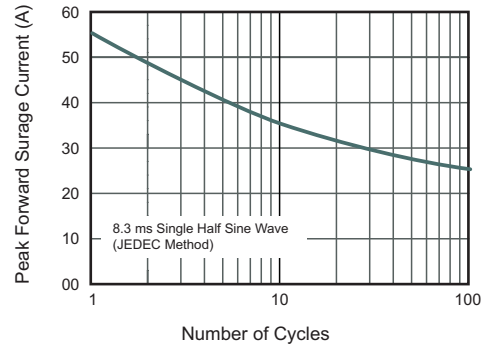

Fig.5 Maximum Non-Repetitive Peak Forward Surge Current





PACKAGE OUTLINE

Plastic surface mounted package; 4 leads

ABS/LBF

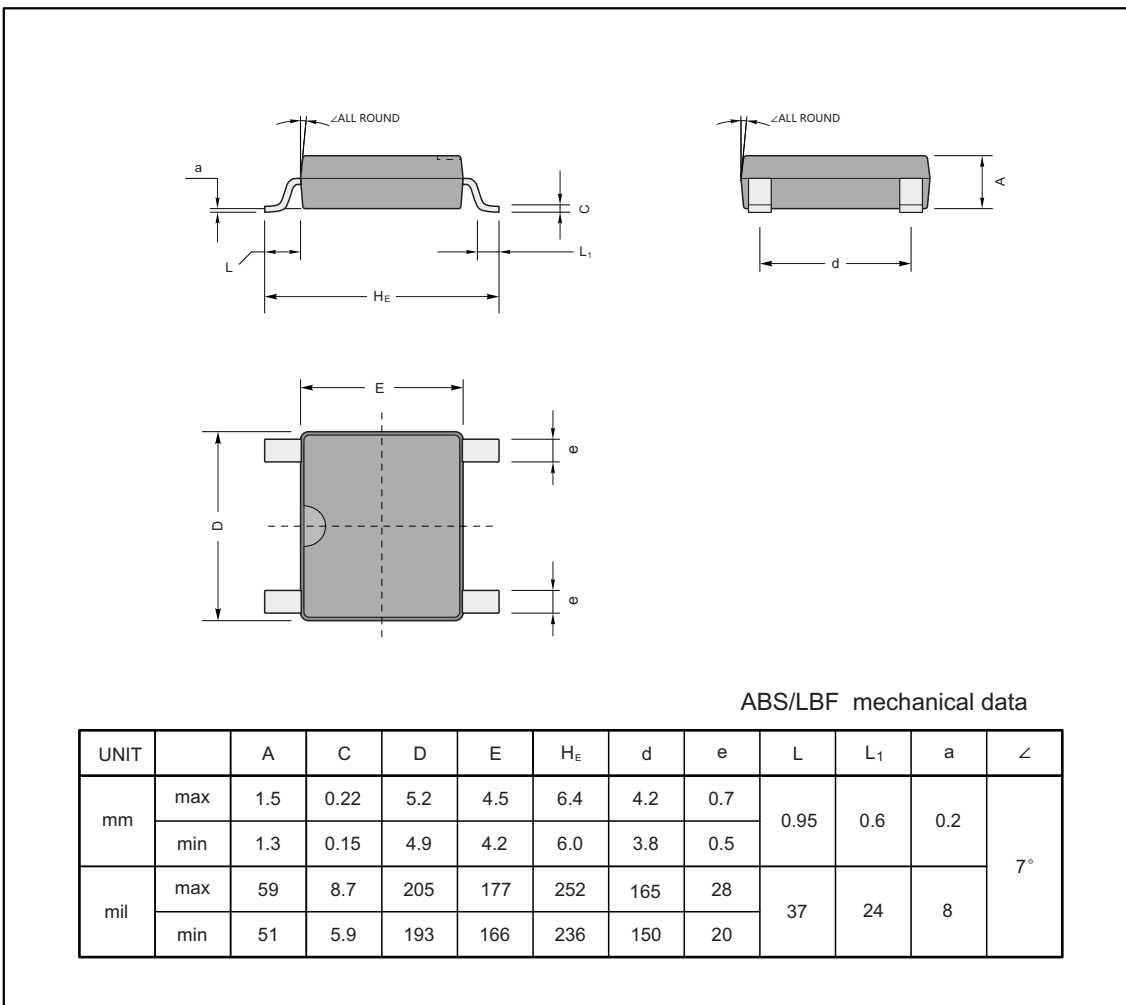

The recommended mounting pad size

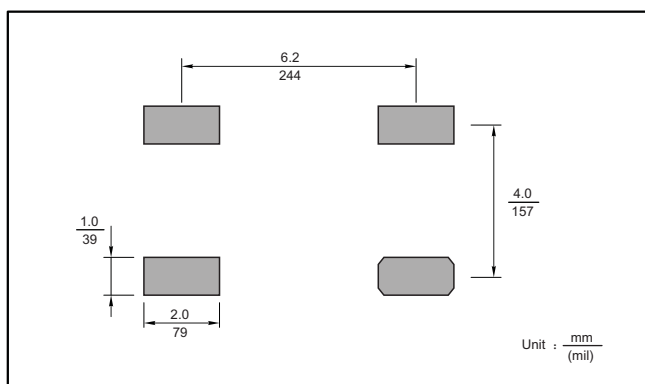

Marking

Type number	Marking code
UTB1S-20	U20T1
UTB 2S-20	U20T 2
UTB 4S-20	U20T4
UTB 6S-20	U20T 6
UTB 8S-20	U20T 8
UTB 10S-20	U20T 10