



6A, 120V PNP TRANSISTOR

TO-220F-3L

TO-220-3L

TO-247-3L

Features

- High breakdown voltage margin
- Abnormal leakage current
- High output power
- High secondary breakdown resistance and reliability
- Complement to 2SC5196

Mechanical data

- Case: TO-220F-3L
- Approx. Weight: 1.7g (0.06oz)
- Case: TO-220-3L
- Approx. Weight: 2.0g (0.07oz)
- Case: TO-220-3L
- Approx. Weight: 6.3g (0.22oz)
- Lead free finish, RoHS compliant
- Case Material: "Green" molding compound, UL flammability classification 94V-0, "Halogen-free".

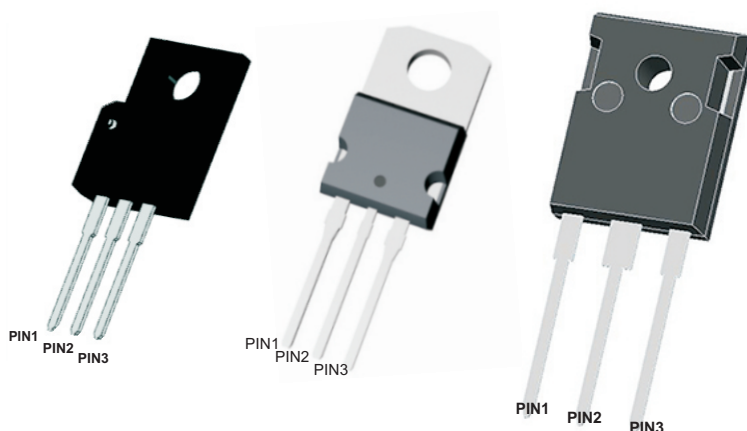

SYMBOL

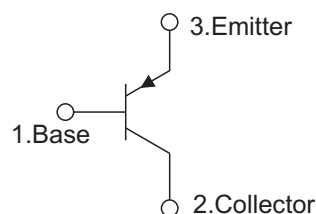

Product specification classification

PRODUCT NAME	PACKAGE TYPE	MARKING	PACKING MATERIAL
F2SA1939	TO-220F-3L	2SA1939	Tube
C2SA1939	TO-220-3L	2SA1939	Tube
W2SA1939	TO-247-3L	2SA1939	Tube

ABSOLUTE MAXIMUM RATINGS (TA=25°C, unless otherwise specified)

PARAMETER	Symbols	RATINGS	Units
Collector-Base Voltage	V_{CBO}	-120	V
Collector-Emitter Voltage	V_{CEO}	-120	V
Emitter-Base Voltage	V_{EBO}	-7	V
Collector Current –Continuous	I_C	-6	A
Collector Power Dissipation	P_C	60	W
Junction Temperature	T_J	150	°C
Storage Temperature	T_J, T_{stg}	-55 ~ +150	°C



THERMAL DATA

PARAMETER	Symbols	F2SA1939	C2SA1939	W2SA1939	Units
Junction to Ambient	R_{thJA}	63			°C/W
Junction to Case	R_{thJC}	1.5	0.7	0.5	°C/W

ELECTRICAL CHARACTERISTICS (TA=25°C, unless otherwise specified)

PARAMETER	Symbols	TEST CONDITIONS	Min	Typ	Max	Units
Collector-base breakdown voltage	$V_{(BR)CBO}$	IC=-1mA,IE=0	-120			V
Collector-emitter breakdown voltage	$V_{(BR)CEO}$	IC=-1mA,IB=0	-120			V
Emitter-base breakdown voltage	$V_{(BR)EBO}$	IE=-1mA,IC=0	-7			V
DC voltage gain	h_{FE1}	VCE=-5V,IC=-1A	70	120	160	
	h_{FE2}	VCE=-5V,IC=-5A	35			
Saturation voltage drop of collector and emitter	$V_{CE(SAT)}$	IC=-2A,IB=-0.2A		-0.16	-0.6	V
Base-Emitter Saturation Voltage	$V_{BE(SAT)}$	IC=-2A,IB=-0.2A		-1.0	-1.5	V
Base and emitter voltage	V_{BE}	VCE=-5V,IC=-7A			-2	V
Collector and base leakage current	I_{CBO}	VCE=-120V,IE=0			-50	uA
Collector and emitter leakage current	I_{CEO}	VEB=-120V,IB=0V			-50	uA
Transition frequency	FT	VCE=-10V,IC=-1A		30		MHZ



PACKAGE OUTLINE
Plastic surface mounted package; 3 leads

TO-220F-3L

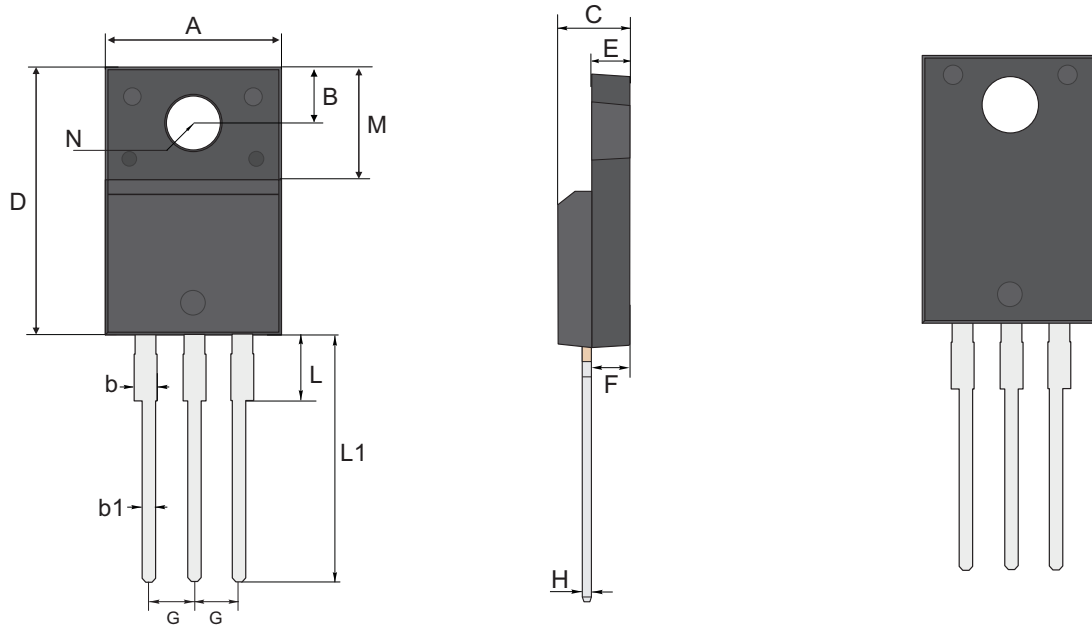

TO-220F-3L mechanical data

UNIT		A	B	b	b1	C	D	E	F	G	H	L	L1	M	N
mm	max	10.28	3.37	1.34	0.9	4.9	16.07	2.74	2.74	2.64	0.60	2.85	13.7	6.88	3.18 TYPICAL
	typ	10.18	3.27	1.24	0.8	4.7	15.87	2.54	2.54	2.54	0.50	2.65	13.5	6.68	
	min	10.08	3.17	1.14	0.7	4.5	15.67	2.34	2.34	2.44	0.40	2.45	13.3	6.48	
mil	max	405	133	53	35	193	630	108	108	104	27	112	539	271	125 TYPICAL
	typ	401	129	49	31	185	590	100	100	100	20	104	531	267	
	min	397	125	45	28	177	580	92	92	96	16	96	524	255	

MARKING DIAGRAM

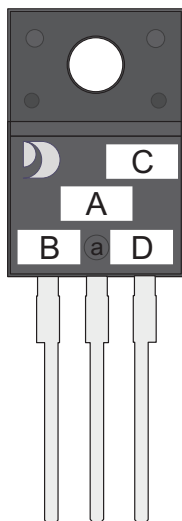

- Unmarkable Surfacea
- Marking Composition Field
- a:Ejector Pin Mark
- A:Marking Area
- B: Lot Code
- C: Additional Information
- D:Date Code (YWW)
- Y:Years(0~9)
- WW:Week



PACKAGE OUTLINE
Plastic surface mounted package; 3 leads

TO-220-3L

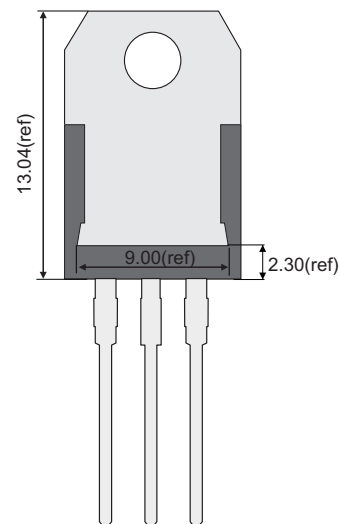
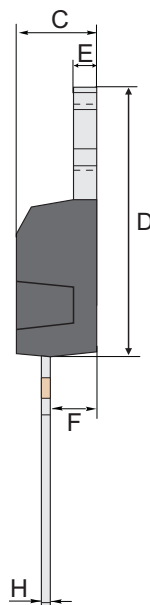
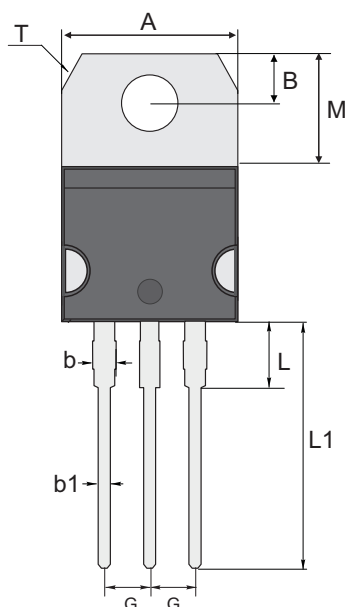

TO-220-3L mechanical data

UNIT		A	B	b	b1	C	D	E	F	G	H	L	L1	M	N	T
mm	max	10.28	2.84	1.48	0.90	4.65	15.54	1.37	2.79	2.64	0.60	3.88	13.13	6.39	3.82 typ	1.19 58° typ
	typ	10.18	2.74	1.33	0.80	4.45	15.34	1.27	2.59	2.54	0.50	3.68	12.93	6.19		
	min	10.08	2.64	1.18	0.70	4.25	15.14	1.17	2.39	2.44	0.40	3.48	12.73	5.99		
mil	max	261	72	38	23	118	395	34	71	67	15	99	334	162	97 typ	30 58° typ
	typ	259	70	34	20	113	390	32	66	65	13	93	328	157		
	min	256	67	30	18	107	385	29	61	62	10	88	323	152		

MARKING DIAGRAM

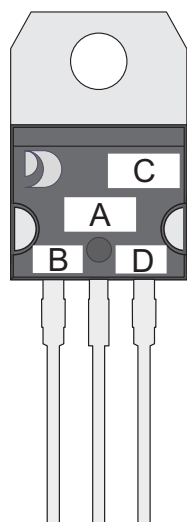

- Unmarkable Surfacea
- Marking Composition Field
- a:Ejector Pin Mark
- A:Marking Area
- B: Lot Code
- C: Additional Information
- D:Date Code (YWW)
- Y:Years(0~9)
- WW:Week



PACKAGE OUTLINE

Plastic surface mounted package; 3 leads

TO-247-3L

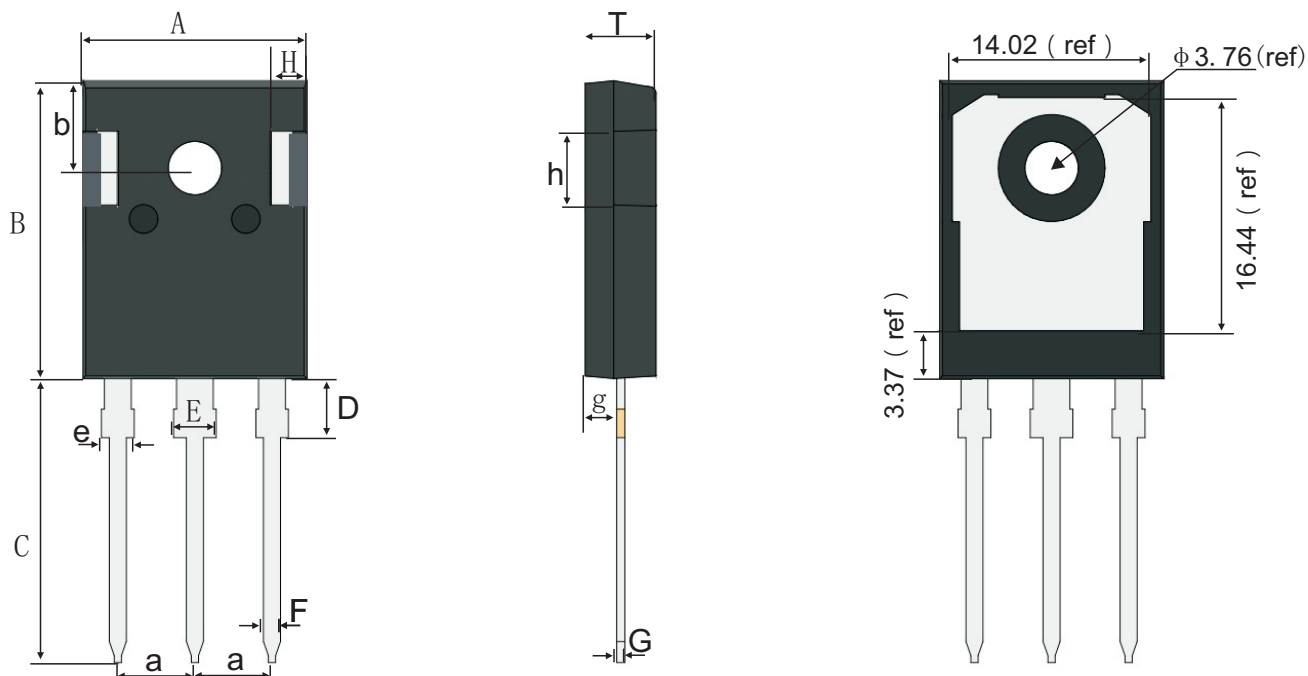

TO-247-3L mechanical data

UNIT		A	B	b	C	D	E	e	F	g	G	T	t	a	H	h
mm	max	16.01	21.18	6.26	20.2	4.25	3.15	2.20	1.30	2.49	0.70	5.20	2.21	5.54	2.71	5.37
	typ	15.81	20.98	6.16	20.0	4.15	3.00	2.05	1.20	2.39	0.60	5.00	2.01	5.44	2.51	5.17
	min	15.61	20.78	6.06	19.8	4.05	2.85	1.90	1.10	2.29	0.50	4.80	1.81	5.34	2.31	4.97
mil	max	630	834	246	795	167	124	87	51	98	28	205	87	218	107	211
	typ	622	826	243	787	163	118	81	47	94	24	197	79	214	99	204
	min	615	818	239	780	159	112	75	43	90	20	189	71	210	91	196

MARKING DIAGRAM

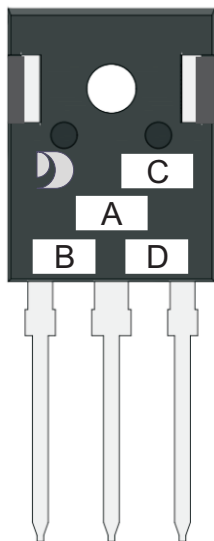

- Unmarkable Surfacea
- Marking Composition Field
- a: Ejector Pin Mark
- A: Marking Area
- B: Lot Code
- C: Additional Information
- D: Date Code (YWW)
- Y: Years(0~9)
- WW: Week



Important Notice and Disclaimer

Jingdao Microelectronics reserves the right to make changes to this document and its products and specifications at any time without notice. Customers should obtain and confirm the latest product information and specifications before final design, purchase or use.

Jingdao Microelectronics makes no warranty, representation or guarantee regarding the suitability of its products for any particular purpose, nor does Jingdao Microelectronics assume any liability for application assistance or customer product design.

Jingdao Microelectronics does not warrant or accept any liability with products which are purchased or used for any unintended or unauthorized application.

No license is granted by implication or otherwise under any intellectual property rights of Jingdao Microelectronics.

Jingdao Microelectronics products are not authorized for use as critical components in life support devices or systems without express written approval of Jingdao Microelectronics.