

**10A, 600V N-CHANNEL
POWER MOSFET**

ITO-220ABW

DESCRIPTION

The F10N60 is a high voltage power MOSFET and is designed to have better characteristics, such as fast switching time, low gate charge, low on-state resistance and have a high rugged avalanche characteristics. This power MOSFET is usually used at high speed switching applications in switching power supplies and adaptors.

Features

- $R_{DS(ON)} \leq 1.0 \Omega @ V_{GS}=10V, I_D=5.0A$
- Fast switching capability
- Avalanche energy tested
- Improved dv/dt capability, high ruggedness

Mechanical data

- Case: ITO-220ABW
- Approx. Weight: 2.1g (0.07oz)
- Lead free finish, RoHS compliant
- Case Material: "Green" molding compound, UL flammability classification 94V-0, "Halogen-free".

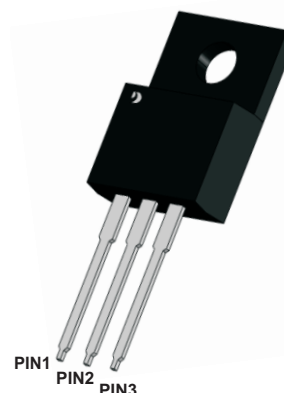

SYMBOL

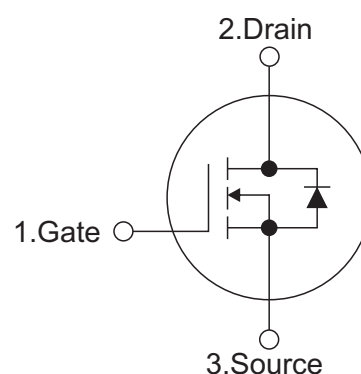

ABSOLUTE MAXIMUM RATINGS (TA=25°C, unless otherwise specified)

PARAMETER		Symbols	RATINGS	Units
Drain-Source Voltage		V_{DSS}	600	V
Gate-Source Voltage		V_{GSS}	± 30	V
Continuous Drain Current	Tc=25°C	I_D	10	A
	Tc=100°C		6.3	A
Pulsed Drain Current (Note 2)		I_{DM}	40	A
Avalanche Energy	Single Pulsed (Note 3)	E_{AS}	654	mJ
Peak Diode Recovery dv/dt (Note 4)		dv/dt	2.1	V/ns
Power Dissipation		P_D	45	W
Operation Junction Temperature and Storage Temperature		T_j, T_{stg}	-55 ~ +150	°C

Notes: 1. Absolute maximum ratings are those values beyond which the device could be permanently damaged.

Absolute maximum ratings are stress ratings only and functional device operation is not implied.

2. Repetitive Rating: Pulse width limited by maximum junction temperature.

3. L = 30mH, IAS = 6A, VDD = 50V, RG = 25 Ω , Starting TJ = 25°C

4. ISD \leq 10A, di/dt \leq 200A/ μ s, VDD \leq BVDSS, Starting TJ = 25°C

THERMAL DATA

PARAMETER	Symbols	RATINGS	Units
Junction to Ambient	R_{thJA}	63	°C/W
Junction to Case	R_{thJC}	2.76	°C/W

Note: Device mounted on FR-4 substrate PC board, 2oz copper, with 1inch square copper plate.



ELECTRICAL CHARACTERISTICS (TA=25°C, unless otherwise specified)

PARAMETER		Symbols	TEST CONDITIONS	Min	Typ	Max	Units	
OFF CHARACTERISTICS								
Drain-Source Breakdown Voltage		BV_{DSS}	$V_{GS}=0V, I_D=250\mu A$	600			V	
Drain-Source Leakage Current		I_{DSS}	$V_{DS}=600V, V_{GS}=0V$			1	μA	
Gate- Source Leakage Current	Forward	I_{GSS}	$V_{GS}=30V, V_{DS}=0V$			100	nA	
	Reverse		$V_{GS}=-30V, V_{DS}=0V$			-100		
ON CHARACTERISTICS								
Gate Threshold Voltage		$V_{GS(TH)}$	$V_{DS}=V_{GS}, I_D=250\mu A$	2.0		4.0	V	
Static Drain-Source On-State Resistance		$R_{DS(ON)}$	$V_{GS}=10V, I_D=5.0A$		0.65	1.0	Ω	
DYNAMIC CHARACTERISTICS								
Input Capacitance		C_{ISS}	$V_{DS}=25V,$ $V_{GS}=0V,$ $f=1.0MHz$		1550		pF	
Output Capacitance		C_{OSS}				140		pF
Reverse Transfer Capacitance		C_{RSS}				12		pF
SWITCHING CHARACTERISTICS								
Total Gate Charge (Note 1)		Q_G	$V_{DS}=480V, V_{GS}=10V,$ $I_D=10A, I_G=1mA$ (NOTE1,2)		28.3		nC	
Gate-Source Charge		Q_{GS}				6.2		nC
Gate-Drain Charge		Q_{GD}				13.2		nC
Turn-On Delay Time (Note 1)		$t_{D(ON)}$	$V_{DS}=100V, V_{GS}=10V,$ $I_D=10A, R_G=25\Omega$ (NOTE1,2)		21.7		ns	
Turn-On Rise Time		t_R				41.8		ns
Turn-Off Delay Time		$t_{D(OFF)}$				79.4		ns
Turn-Off Fall Time		t_F				40.9		ns
DRAIN-SOURCE DIODE CHARACTERISTICS AND MAXIMUM RATINGS								
Maximum Body-Diode Continuous Current		I_S				10	A	
Maximum Body-Diode Pulsed Current		I_{SM}				40	A	
Drain-Source Diode Forward Voltage (Note 1)		V_{SD}	$I_S=10A, V_{GS}=0V$			1.3	V	
Reverse Recovery Time (Note 1)		t_{rr}	$I_S=10A, V_{GS}=0V,$			542	ns	
Reverse Recovery Charge		Q_{rr}	$di/dt=100A/\mu s$			4.18	μC	

Notes:

1. Pulse Test: Pulse width $\leq 300\mu s$, Duty cycle $\leq 2\%$.
2. Essentially independent of operating temperature.



Test Circuits and waveforms

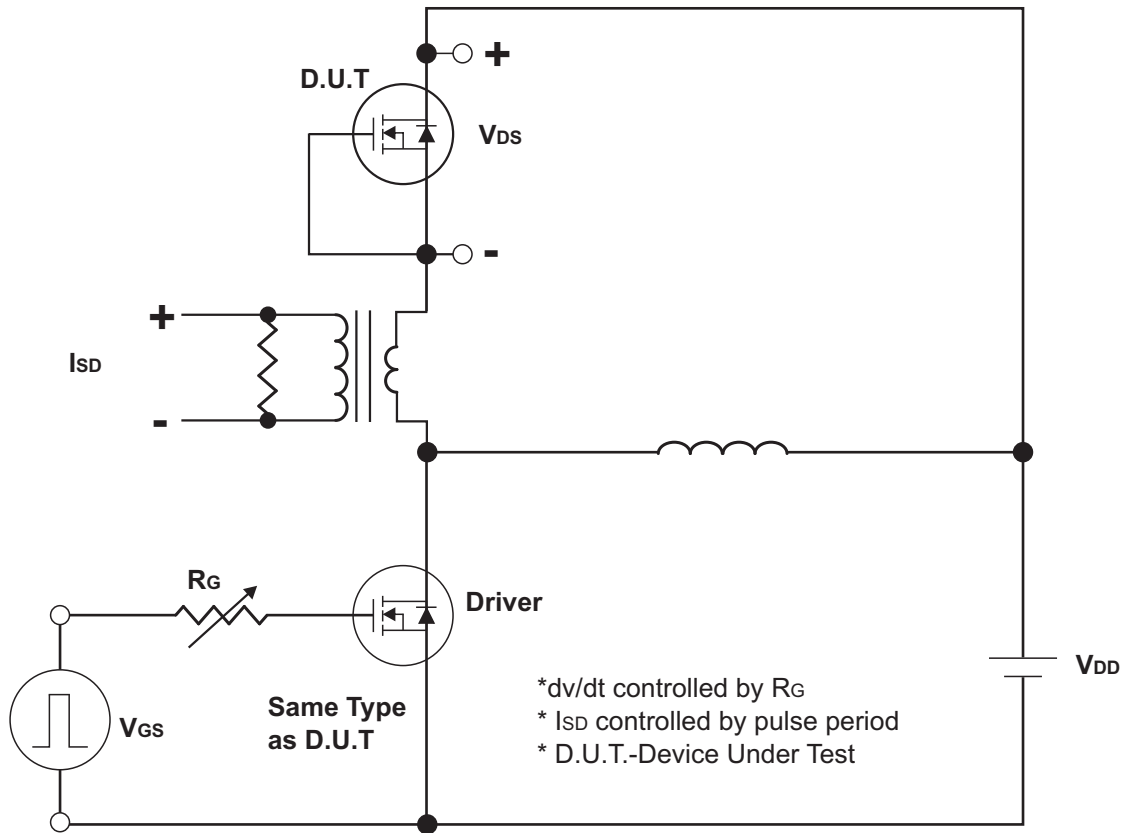

Peak Diode Recovery dv/dt Test Circuit

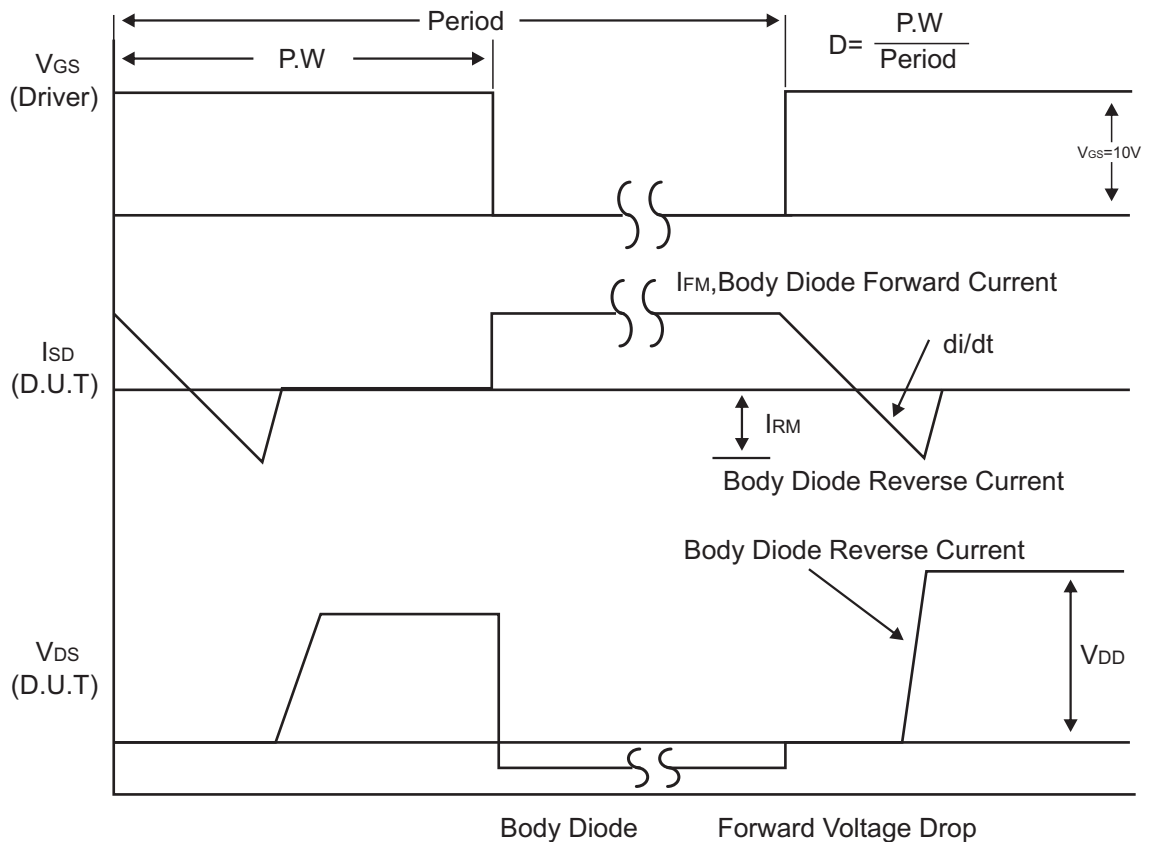

Peak Diode Recovery dv/dt Waveforms



Test Circuits and waveforms

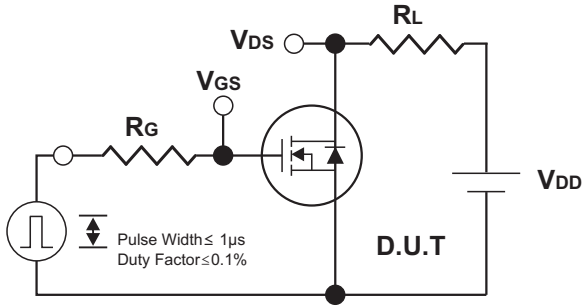

Switching Test Circuit

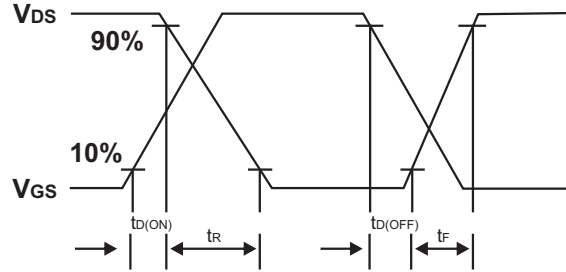

Switching Waveforms

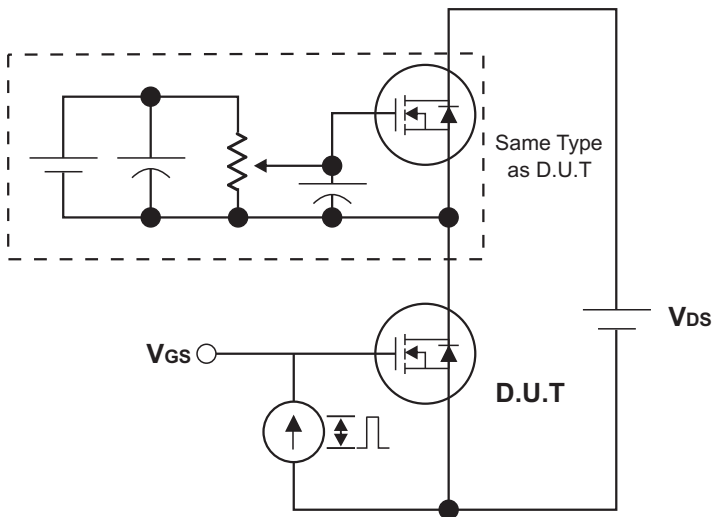

Gate Charge Test Circuit

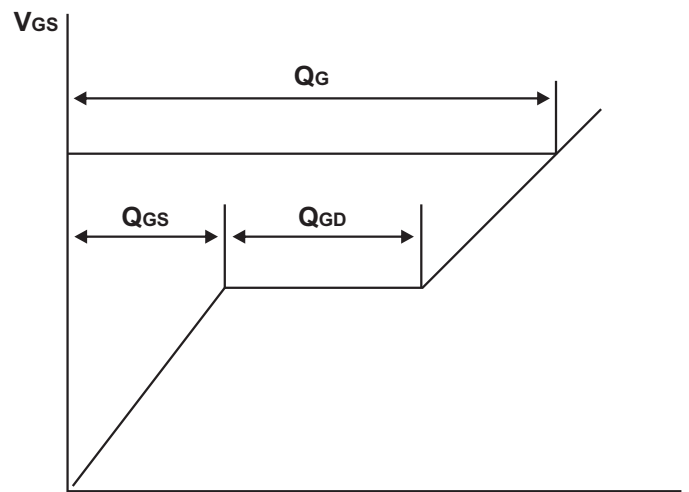

Charge
Gate Charge Waveform

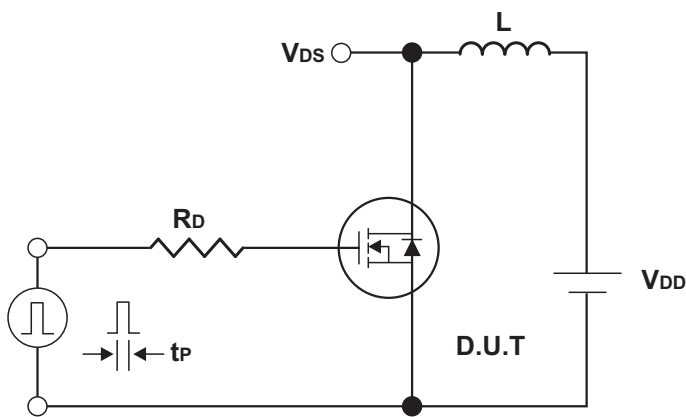

Unclamped Inductive Switching Test Circuit

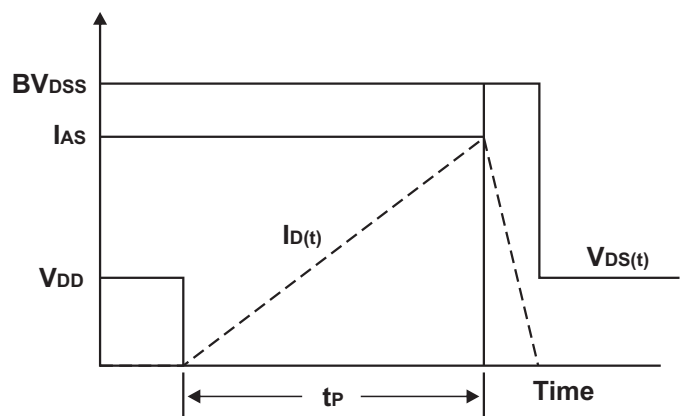

Unclamped Inductive Switching Waveforms



Typical Characteristics

Fig.1 Drain Current vs. Gate-Source Voltage

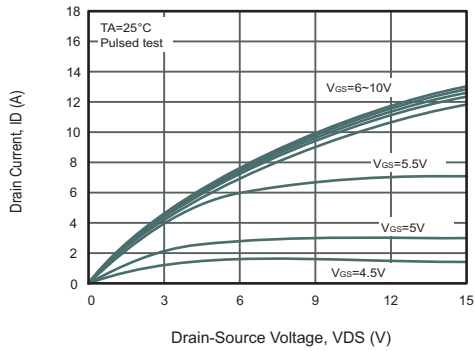

Fig.2 Drain-Source On-Resistance vs. Gate-Source Voltage

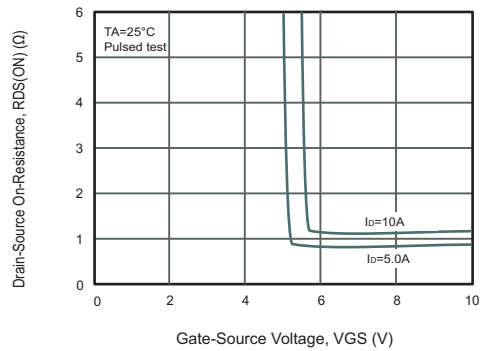

Fig.3 Gate Charge Characteristics

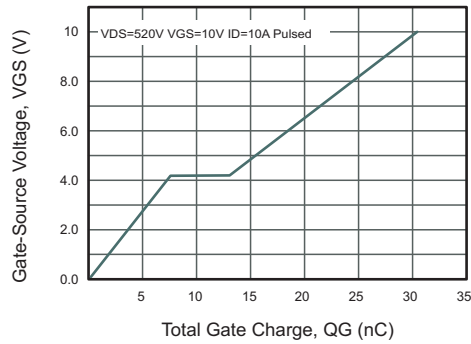

Fig.4 Capacitance Characteristics

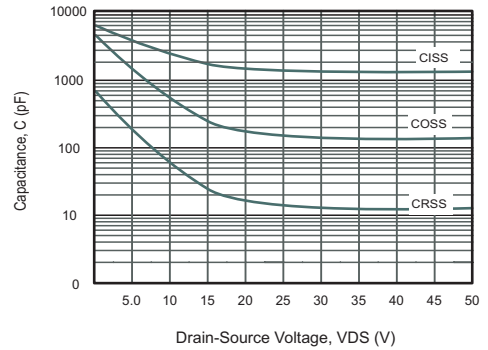

Fig.5 Drain-Source On-Resistance vs. Junction Temperature

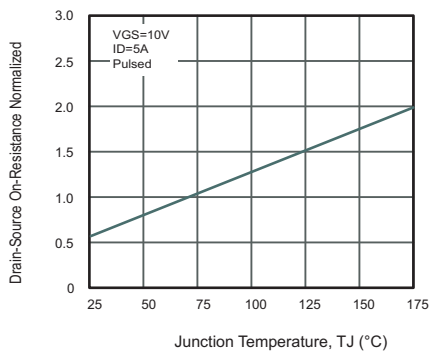

Fig.6 Breakdown Voltage vs. Junction Temperature

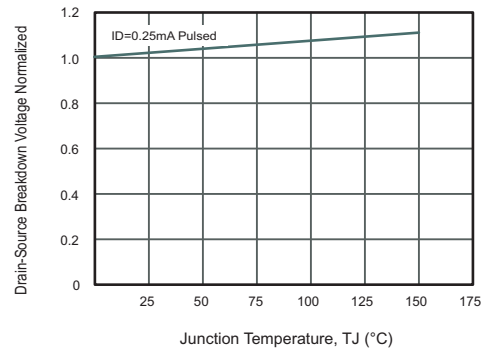

Fig.7 Gate Threshold Voltage vs. Junction Temperature

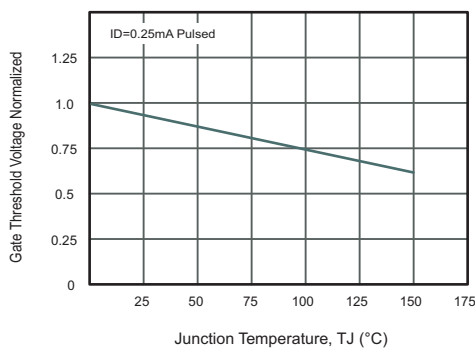
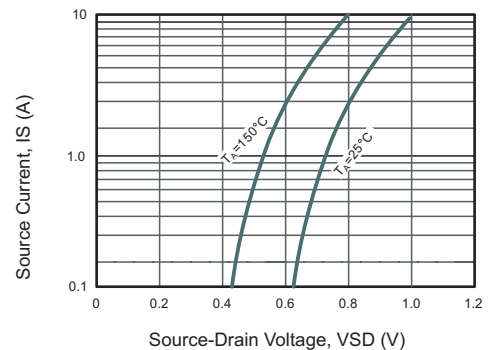

Fig.8 Source Current vs. Source-Drain Voltage





Typical Characteristics

Fig.9 Drain Current vs. Gate-Source Voltage

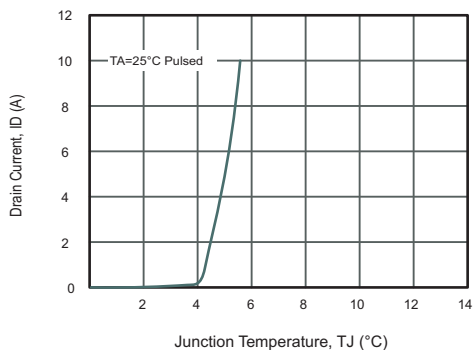

Fig.10 Drain-Source On-Resistance vs. Drain Current

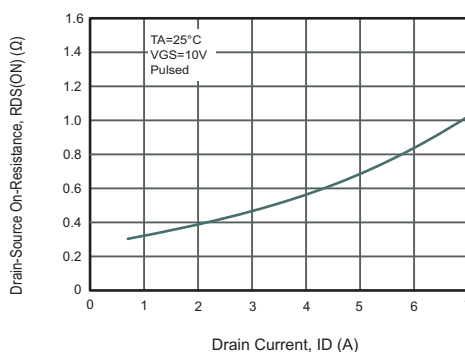

Fig.11 Power Dissipation vs. Junction Temperature

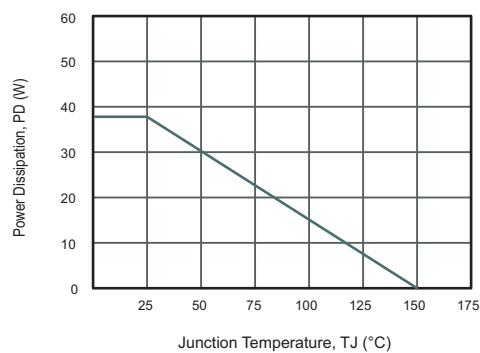

Fig.12 Drain Current vs. Junction Temperature

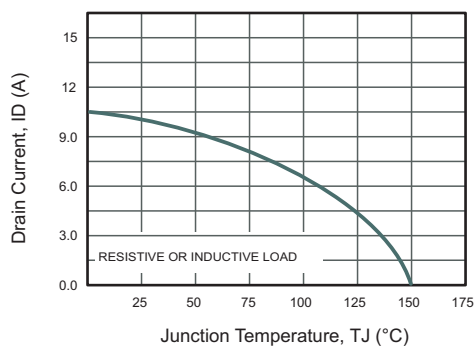
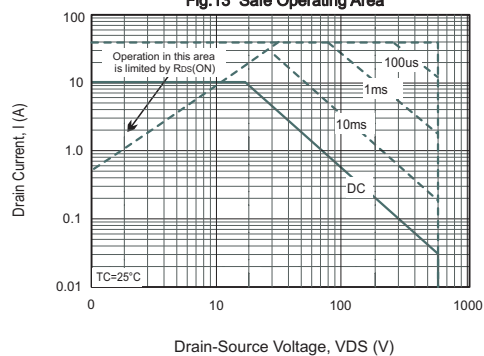

Fig.13 Safe Operating Area





PACKAGE OUTLINE

Plastic surface mounted package; 3 leads

ITO-220ABW

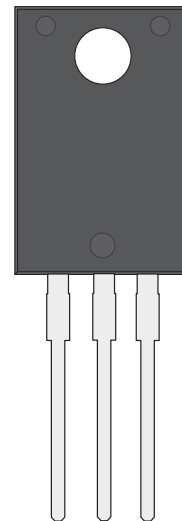
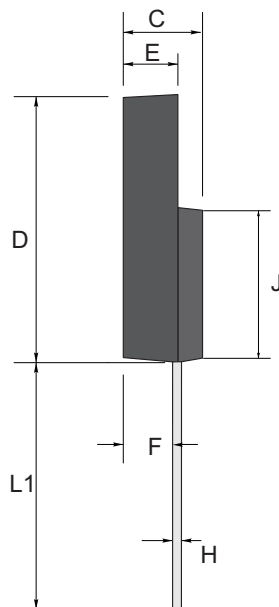
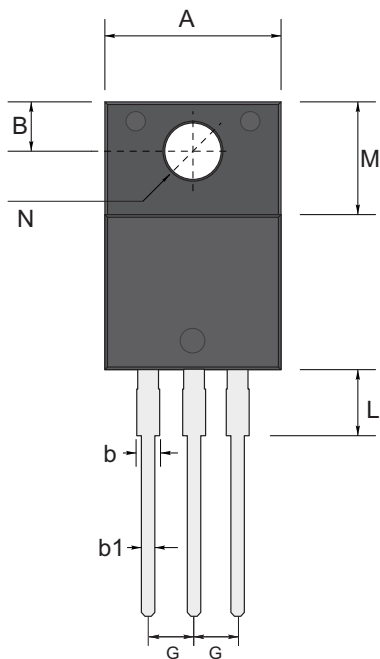

ITO-220ABW mechanical data

UNIT		A	B	b	b1	C	D	E	F	G	H	L	L1	M	N
mm	max	10.5	2.85	1.4	0.8	4.7	16.0	2.9	2.8	2.54 TYPICAL	0.70	2.9	14.3	7.0	3.4 TYPICAL
	typ	10.0	2.70	1.2	0.6	4.5	15.0	2.7	2.7		0.55	2.5	13.5	6.8	
	min	9.85	2.54	1.1	0.5	4.4	14.7	2.5	2.5		0.41	2.3	13.0	6.3	
mil	max	413	112	55	31	185	630	114	110	100 TYPICAL	27	114	563	276	133 TYPICAL
	typ	394	106	47	24	177	590	106	106		22	98	531	267	
	min	388	100	43	20	173	580	98	98		16	91	512	248	

MARKING DIAGRAM

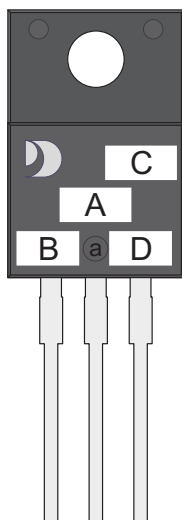

- Unmarkable Surfacea
- Marking Composition Field
- a: Ejector Pin Mark
- A: Marking Area
- B: Lot Code
- C: Additional Information
- D: Date Code (YWW)
- Y: Years(0~9)
- WW: Week



Important Notice and Disclaimer

Jingdao Microelectronics reserves the right to make changes to this document and its products and specifications at any time without notice. Customers should obtain and confirm the latest product information and specifications before final design, purchase or use.

Jingdao Microelectronics makes no warranty, representation or guarantee regarding the suitability of its products for any particular purpose, nor does Jingdao Microelectronics assume any liability for application assistance or customer product design.

Jingdao Microelectronics does not warrant or accept any liability with products which are purchased or used for any unintended or unauthorized application.

No license is granted by implication or otherwise under any intellectual property rights of Jingdao Microelectronics.

Jingdao Microelectronics products are not authorized for use as critical components in life support devices or systems without express written approval of Jingdao Microelectronics.